



Waiheke Private Residence, Colmain Electrical

D-LIGHTZ

Ambient lighting with impact

The D-LIGHTZ range was our 2nd generation of lighting products, which are ideal for when you want to create a relaxed atmosphere or draw a delicate focus to décor features. Our D-LIGHTZ directional downlights harness our Pure Colour technology to render rich, natural colours for unrivalled depth and definition.

Available in both the Pure Colour Professional Series (90+CRI) and Art Series (97+ CRI), Sunset Dimming is also an option if you want superior mood lighting capabilities.

D-LIGHTZ Fixed and Tilt are designed to perfectly replace 50W halogen fittings.



Available in four styles – Tilt, Deep Tilt, Offset Deep Tilt, and Fixed – our D-LIGHTZ come in a range of lumen outputs from 470Lm to over 1000Lm, plus Ultra Low Glare, Prismatic and Opaque diffused lighting options.

E-LIGHTZ

Visual clarity in every environment

The E-LIGHTZ range was our 1st generation of lighting products and they are ideal for general illumination in hallways, bathrooms and bedrooms. Our E-LIGHTZ wide-angle downlights use Pure Colour technology to enhance the tones, textures and surfaces of every space.

Designed to replace incandescent recessed light models, our E-LIGHTZ are perfect for when you want to maximise illumination and minimise running costs, – recommended for retrofits to reduce your energy consumption by as much as 88%.



Sharing the same trim profile as our D-LIGHTZ series, the E-LIGHTZ and E-LIGHTZ Mini models provide high-quality light in the Pure Colour Professional Series (CRI 90+).

Available in Sunset Dimming or fixed colour temperatures, we also offer a range of beam angles and lumen outputs.

D-LIGHTZ *Tilt*



Golden Bay private residence



SL112T
ULG clear glass
Beam 20° 40° 60°
Task | General lighting



SL111T
Prismatic diffuser
Beam 20° 40° 60°
General | Task lighting



SL113T
Opaque diffuser
Beam 90°
Wide angle lighting



D-LIGHTZ Tilt

- + wide range of beam angles with a 26° tilt
- + fully adjustable 360° gimbal
- + suitable for indoor use and exterior under soffits
- + IP65 front
- + perfect for retrofit to replace 50W halogen
- + constant current

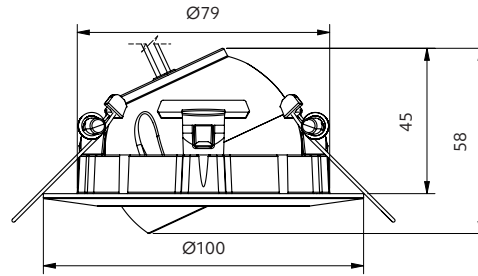

Options

Beam angle

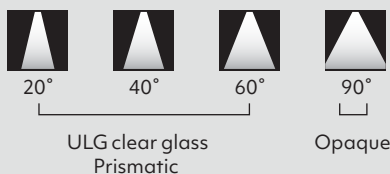

CCT



CRI

Professional series (P) CRI 90 Art series (A) CRI 97

Trim colour

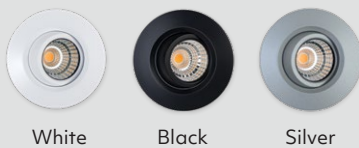

Driver included – to be specified

Phase cut Dimming
Special request:
 DALI 2 Dimming
 SLiC Casambi Dimming

Use with

D-LIGHTZ adapter plates for retrofit installations

9-36VDC input options available
 Scan the QR code for low voltage driver options



Product information

Table is based on: White, prismatic, 40°, 3000K, CRI 90, phase cut driver
 Contact Switch Lighting for data of other variants

Driver (mA)	Power (W)	Delivered lumens (lm)	Insulation coverable		
			NZ	AU	UK/EU
150	6.8	550	IC-F	IC-4	✓
220	9.2	800	IC-F	IC-4	✓
300	13.2	1000	CA135	Do not cover	✓



*Specification is for ceiling material ≤ 13mm with a phase cut driver.

How to specify D-LIGHTZ Tilt

Please confirm model option availability from our website. **Not every combination is compatible.**

e.g. code = **SL111T-40-30-P-W**

Model	Beam	CCT	CRI	Trim Colour	Driver – Phase cut*	Market
SL112T = ULG clear glass SL111T = Prismatic	20 = 20° 40 = 40° 60 = 60°	27 = 2700K 30 = 3000K 40 = 4000K SD = Sunset Dimming	P = 90 A = 97	W = White B = Black S = Silver	D09 = 150mA (6.8W) D09 = 220mA (9.2W) D12 = 300mA (13.2W)	= NZ 1 = Aust 2 = UK 3 = EU
SL113T = Opaque	90 = 90°				*Check online for driver options.	

Please see www.switch-lighting.co.nz for full specifications, lux levels, SDoCs, ies files and installation instructions.



Warranty
 7yr Luminaire
 5yr Driver

L70 (60,000h)

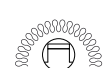

D-LIGHTZ *Deep Tilt*



SLDL122T
ULG clear glass
Beam 20° 40° 60°
Task | General lighting



SLDL121T
Prismatic diffuser
Beam 20° 40° 60°
General | Task lighting



SLDL123T
Opaque diffuser
Beam 90°
Wide angle lighting



D-LIGHTZ *Deep Tilt*

- + fully adjustable 360° gimbal
- + 15° tilt
- + suitable for indoor use and exterior under soffits
- + recessed for low glare
- + IP65 front

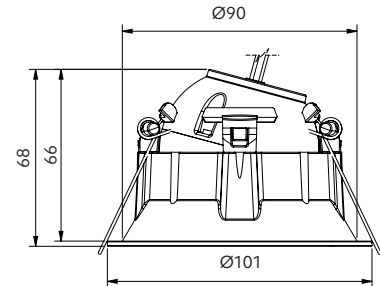

Options

Beam angle

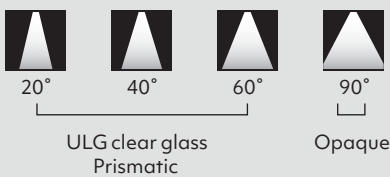

CCT



CRI

Professional series (P) CRI 90 Art series (A) CRI 97

Trim colour

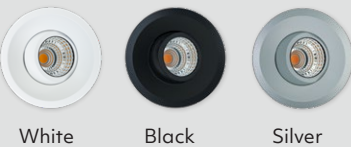

Driver included – to be specified

Phase cut Dimming

Special request:

- DALI 2 Dimming
- SLiC Casambi Dimming

Use with

D-LIGHTZ adapter plates for retrofit installations

9-36VDC input options available
Scan the QR code for low voltage driver options



Product information

Table is based on: White, prismatic, 40°, 3000K, CRI 90, phase cut driver
Contact Switch Lighting for data of other variants

Driver (mA)	Power (W)	Delivered lumens (lm)	Insulation coverable		
			NZ	AU	UK/EU
150	6.8	550	IC-F	IC-4	✓
220	9.2	800	IC-F	IC-4	✓
300	13.2	1000	CA135	Do not cover	✓



*Specification is for ceiling material ≤ 13mm with a phase cut driver.

How to specify D-LIGHTZ Deep Tilt

Please confirm model option availability from our website. **Not every combination is compatible.**

e.g. code = **SLDL121T-40-30-P-W**

Model	Beam	CCT	CRI	Trim Colour	Driver – Phase cut*	Market
SLDL122T = ULG clear glass SLDL121T = Prismatic	20 = 20° 40 = 40° 60 = 60°	27 = 2700K 30 = 3000K 40 = 4000K SD = Sunset Dimming	P = 90 A = 97	W = White B = Black S = Silver	D09 = 150mA (6.8W) = 220mA (9.2W) D12 = 300mA (13.2W)	 = NZ 1 = Aust 2 = UK 3 = EU
SLDL123T = Opaque	90 = 90°				*Check online for driver options.	

Please see www.switch-lighting.co.nz for full specifications, lux levels, SDoCs, ies files and installation instructions.



Warranty
7yr Luminaire
5yr Driver

L70 (60,000 h)

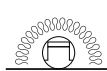

D-LIGHTZ *Offset Deep Tilt*



Nelson private residence
R Fry Builders | Keeping Current Electrical



SLDL152T
ULG clear glass
Beam 20° 40° 60°
Task | General lighting



SLDL151T
Prismatic diffuser
Beam 20° 40° 60°
General | Task lighting



SLDL153T
Opaque diffuser
Beam 90°
Wide angle lighting



D-LIGHTZ *Offset Deep Tilt*

- + fully adjustable 360° gimbal
- + 20° offset, 15° tilt
- + suitable for indoor use and exterior under soffits
- + recessed for low glare
- + IP65 front
- + constant current

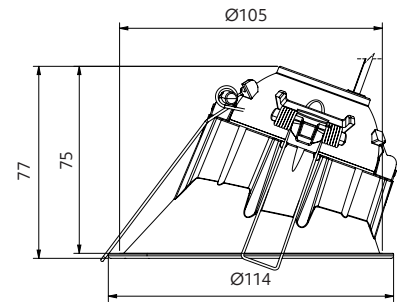

Options

Beam angle

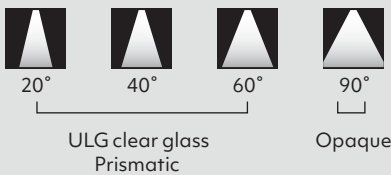

CCT



CRI

Professional series (P) CRI 90 Art series (A) CRI 97

Trim colour

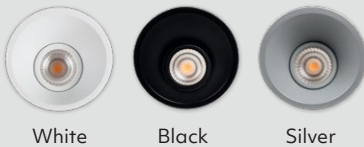

Driver included – to be specified

Phase cut Dimming

Special request:

- DALI 2 Dimming
- SLiC Casambi Dimming

9-36VDC input options available
Scan the QR code for low voltage driver options



Product information

Table is based on: White, prismatic, 40°, 3000K, CRI 90, phase cut driver
Contact Switch Lighting for data of other variants

Driver (mA)	Power (W)	Delivered lumens (lm)	Insulation coverable		
			NZ	AU	UK/EU
150	6.8	550	IC-F	IC-4	✓
220	9.2	800	IC-F	IC-4	✓
300	13.2	1000	CA135	CA90	✓



*Specification is for ceiling material ≤ 13mm with a phase cut driver.

How to specify D-LIGHTZ Offset Deep Tilt

Please confirm model option availability from our website. **Not every combination is compatible.**

e.g. code = **SLDL151T-40-30-P-W**

Model	Beam	CCT	CRI	Trim Colour	Driver – Phase cut*	Market
SLDL152T = ULG clear glass SLDL151T = Prismatic	20 = 20° 40 = 40° 60 = 60°	27 = 2700K 30 = 3000K 40 = 4000K SD = Sunset Dimming	P = 90 A = 97	W = White B = Black S = Silver	D09 = 150mA (6.8W) = 220mA (9.2W) D12 = 300mA (13.2W)	 = NZ 1 = Aust 2 = UK 3 = EU
SLDL153T = Opaque	90 = 90°				*Check online for driver options.	

Please see www.switch-lighting.co.nz for full specifications, lux levels, SDoCs, ies files and installation instructions.



Warranty
7yr Luminaire
5yr Driver

L70 (60,000 h)

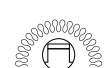

D-LIGHTZ Fixed



The Grand by SkyCity, Auckland



SL112LG
ULG clear glass
Beam 20° 40° 60°
Task | General lighting



SL111LG
Prismatic diffuser
Beam 20° 40° 60°
General | Task lighting

Scan to view website



D-LIGHTZ Fixed

- + compact size
- + recessed for low glare
- + suitable for indoor use and exterior under soffits
- + IP65 front
- + perfect for retrofit to replace 50W halogen
- + constant current

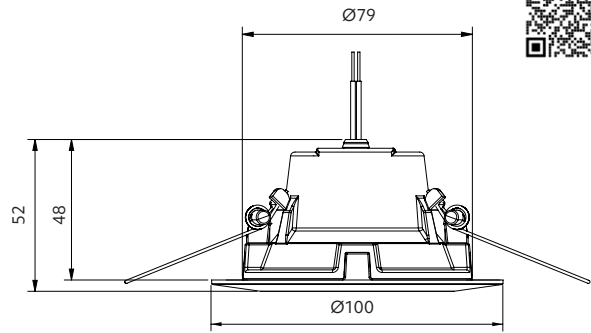

Options

Beam angle



ULG clear glass
Prismatic

CCT



CRI

Professional series (P) CRI 90 Art series (A) CRI 97

Trim colour

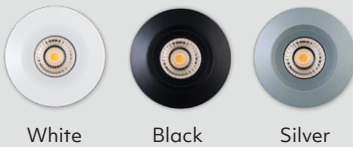

Driver included – to be specified

Phase cut Dimming
Special request:
DALI 2 Dimming
SLiC Casambi Dimming

Use with

D-LIGHTZ adapter plates for retrofit installations

9-36VDC input options available
Scan the QR code for low voltage driver options



Product information

Table is based on: White, prismatic, 40°, 3000K, CRI 90, phase cut driver
Contact Switch Lighting for data of other variants

Driver (mA)	Power (W)	Delivered lumens (lm)	Insulation coverable		
			NZ	AU	UK/EU
150	6.8	550	IC-F	IC-4	✓
220	9.2	800	IC-F	IC-4	✓
300	13.2	1000	CA135	IC-4	✓



*Specification is for ceiling material ≤ 13mm with a phase cut driver.

How to specify D-LIGHTZ Fixed

Please confirm model option availability from our website. **Not every combination is compatible.**

e.g. code = **SL111LG-40-30-P-W**

Model	Beam	CCT	CRI	Trim Colour	Driver – Phase cut*	Market
SL112LG = ULG clear glass SL111LG = Prismatic	20 = 20° 40 = 40° 60 = 60°	27 = 2700K 30 = 3000K 40 = 4000K SD = Sunset Dimming	P = 90 A = 97	W = White B = Black S = Silver	D09 = 150mA (6.8W) 30 = 220mA (9.2W) D12 = 300mA (13.2W) *Check online for driver options.	1 = NZ 1 = Aust 2 = UK 3 = EU

Please see www.switch-lighting.co.nz for full specifications, lux levels, SDoCs, ies files and installation instructions.



Warranty
7yr Luminaire
5yr Driver

L70 (60,000 h)

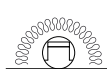

E-LIGHTZ



SL40 | SL40LP | SL40SD
Opaque diffuser
Beam 110°
Wide angle lighting



E-LIGHTZ

- + suitable for retrofit and new installations
- + wide beam angle
- + low power option
- + IP65 front
- + perfect for retrofit to replace 100W incandescent
- + ideal for bathrooms, walk-in wardrobes
- + constant current

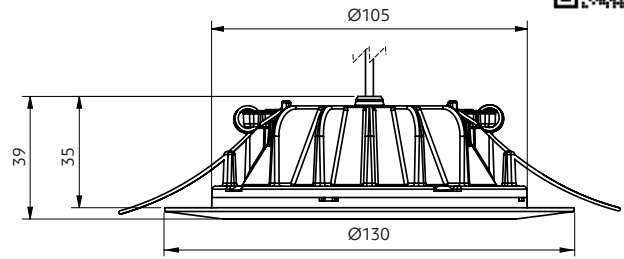

Options

Beam angle



110°

Diffuser

Opaque

Trim colour



White



Black



Silver

CCT



2700K



3000K



4000K



Sunset Dimming
3000-2000K

CRI

Professional series (P) CRI 90

Driver included – to be specified

Phase cut Dimming

Special request:

DALI 2 Dimming

SLiC Casambi Dimming

Use with

E-LIGHTZ adapter plates for retrofit installations



9-36VDC input options available

Scan the QR code for low voltage driver options

Product information

Table is based on: White, 3000K, CRI 90

Contact Switch Lighting for data of other variants

Driver (mA)	Power (W)	Delivered lumens (lm)	Insulation coverable		
			NZ	AU	UK/EU
150	6.8	590	IC-F	IC-4	✓
300	12.4	1060	IC-F	IC-4	✓



Size
130x35mm



Cut-out
Ø101-120mm



Hole depth
>37mm



Front

How to specify E-LIGHTZ

Please confirm model option availability from our website. **Not every combination is compatible.**

e.g. code = **SL40-30-P-W**

Model	CCT	Version	CRI	Trim Colour	Market
SL40	27 = 2700K 30 = 3000K 40 = 4000K SD = Sunset Dimming*	■ = Standard power LP = Low power	P = 90	W = White B = Black S = Silver	■ = NZ 1 = Aust 2 = UK 3 = EU

*Check online for driver options.

Please see www.switch-lighting.co.nz for full specifications, lux levels, SDoCs, ies files and installation instructions.



Warranty
7yr Luminaire
5yr Driver

L70 (60,000 h)

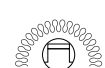

E-LIGHTZ Mini



Private residence Whangaparaoa



SL35 | SL35LP | SL35SD
Opaque diffuser
Beam 100°
Wide angle lighting

E-LIGHTZ Mini

- + trim matches D-LIGHTZ Tilt and Fixed
- + low power option
- + suitable for indoor and exterior soffits
- + IP65 front
- + constant current

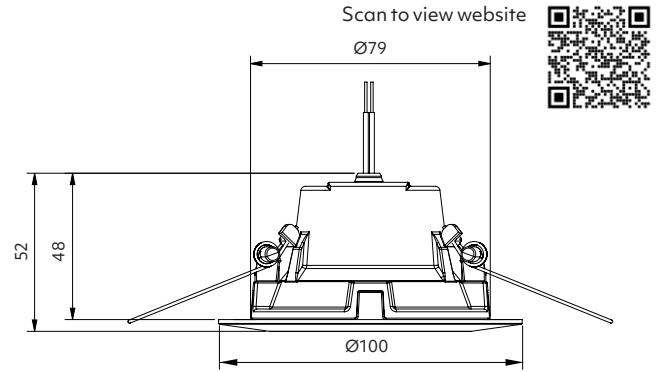

Options

Beam angle



100°

Diffuser

Opaque

Trim colour



White



Black



Silver

CCT



2700K



3000K



4000K



Sunset Dimming
3000-2000K

CRI

Professional series (P) CRI 90

Driver included – to be specified

Phase cut Dimming

Special request:

DALI 2 Dimming

SLiC Casambi Dimming

Use with

E-LIGHTZ adapter plates for retrofit installations

9-36VDC input options available
Scan the QR code for low voltage driver options



Product information

Table is based on: 3000K, CRI 90

Contact Switch Lighting for data of other variants

Driver (mA)	Power (W)	Delivered lumens (lm)	Insulation coverable		
			NZ	AU	UK/EU
150	6.8	550	IC-F	IC-4	✓
220	9.2	780	IC-F	IC-4	✓



Size
100x48mm



Cut-out
Ø83-92mm



Hole depth
>50mm**



Front

**Specification is for ceiling material ≤ 13mm.

How to specify E-LIGHTZ Mini

Please confirm model option availability from our website. **Not every combination is compatible.**

e.g. code = **SL35-30-P-W**

Model	CCT	Version	CRI	Trim Colour	Market
SL35	27 = 2700K 30 = 3000K 40 = 4000K SD = Sunset Dimming*	■ = Standard power LP = Low power	P = 90	W = White B = Black S = Silver	■ = NZ 1 = Aust 2 = UK 3 = EU

*Check online for driver options.

Please see www.switch-lighting.co.nz for full specifications, lux levels, SDoCs, ies files and installation instructions.



Warranty
7yr Luminaire
5yr Driver

 L70 (60,000 h)

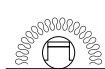

Adapter Plates



D-LIGHTZ Tilt / D-LIGHTZ Fixed / E-LIGHTZ Mini



SLSUP-100-130-W

130mm diameter
(Ø100-115mm cut-out)

SLSUP-100-130-B (black)
SLSUP-100-130-S (silver)
SLSUP-100-130-W (white)



SLSUP-100-155-W

155mm diameter
(Ø100-140mm cut-out)

SLSUP-100-155-B (black)
SLSUP-100-155-S (silver)
SLSUP-100-155-W (white)

D-LIGHTZ Deep Tilt



SLSUP-101-S-W

122mm single square
(Ø108-114mm cut-out)

SLSUP-101-S-B (black)
SLSUP-101-S-S (silver)
SLSUP-101-S-W (white)



SLSUP-101-D-W

122 x 233mm double rectangular
(2 x Ø108-114mm cut-outs)

SLSUP-101-D-B (black)
SLSUP-101-D-S (silver)
SLSUP-101-D-W (white)



SLSUP-101-120-W

120mm diameter
(Ø92-111mm cut-out)

SLSUP-101-120-B (black)
SLSUP-101-120-S (silver)
SLSUP-101-120-W (white)

E-LIGHTZ



SLSUP-130-155-W

155mm diameter
(Ø105-140mm cut-out)

SLSUP-130-155-B (black)
SLSUP-130-155-S (silver)
SLSUP-130-155-W (white)

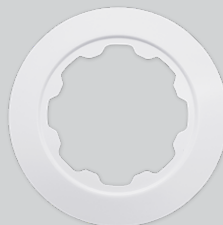

SLSUP-130-185-W

185mm diameter
(Ø105-170mm cut-out)

SLSUP-130-185-B (black)
SLSUP-130-185-S (silver)
SLSUP-130-185-W (white)

Trim colour



White

Black

Silver

All luminaires ordered separately

Scan to view
website

